

# INTERNATIONAL STANDARD

# ISO 4433-1

First edition  
1997-12-15

---

---

## Thermoplastics pipes — Resistance to liquid chemicals — Classification —

### Part 1: Immersion test method

*Tubes en matières thermoplastiques — Résistance aux liquides  
chimiques — Classification —*

*Partie 1: Méthode d'essai d'immersion*

This material is reproduced from ISO documents under International Organization for Standardization (ISO) Copyright License number IHS/ICC/1996. Not for resale. No part of these ISO documents may be reproduced in any form, electronic retrieval system or otherwise, except as allowed in the copyright law of the country of use, or with the prior written consent of ISO (Case postale 56, 1211 Geneva 20, Switzerland, Fax +41 22 734 10 79), IHS or the ISO Licensor's members.



Reference number  
ISO 4433-1:1997(E)

**ISO 4433-1:1997(E)****Foreword**

ISO (the International Organization for Standardization) is a worldwide federation of national standards bodies (ISO member bodies). The work of preparing International Standards is normally carried out through ISO technical committees. Each member body interested in a subject for which a technical committee has been established has the right to be represented on that committee. International organizations, governmental and non-governmental, in liaison with ISO, also take part in the work. ISO collaborates closely with the International Electrotechnical Commission (IEC) on all matters of electrotechnical standardization.

Draft International Standards adopted by the technical committees are circulated to the member bodies for voting. Publication as an International Standard requires approval by at least 75 % of the member bodies casting a vote.

International Standard ISO 4433-1 was prepared by Technical Committee ISO/TC 138, *Plastics pipes, fittings and valves for the transport of fluids*, Subcommittee SC 3, *Plastics pipes and fittings for industrial applications*.

Together with the other parts (see below), this part of ISO 4433 cancels and replaces ISO 4433:1984, which has been technically revised.

ISO 4433 consists of the following parts, under the general title *Thermoplastics pipes — Resistance to chemical fluids — Classification*:

- *Part 1: Immersion test method*
- *Part 2: Polyolefin pipes*
- *Part 3: Unplasticized poly(vinyl chloride) (PVC-U), high-impact poly(vinyl chloride) (PVC-HI) and chlorinated poly(vinyl chloride) (PVC-C) pipes*
- *Part 4: Poly(vinylidene fluoride) (PVDF) pipes*

Annexes A to C of this part of ISO 4433 are for information only.

© ISO 1997

All rights reserved. Unless otherwise specified, no part of this publication may be reproduced or utilized in any form or by any means, electronic or mechanical, including photocopying and microfilm, without permission in writing from the publisher.

International Organization for Standardization  
Case postale 56 • CH-1211 Genève 20 • Switzerland  
Internet central@iso.ch  
X.400 c=ch; a=400net; p=iso; o=isocs; s=central

Printed in Switzerland

## Introduction

Because of their varied applications, thermoplastics pipes are frequently required to convey or be in contact with materials such as chemical products, fuels, lubricants, and sometimes their vapours.

Under the action of a liquid, the wall of a thermoplastics pipe can be the location for several concurrent phenomena; on the one hand, absorption of liquid and/or extraction of its soluble constituents from the pipe walls into the liquid; on the other hand, a chemical reaction usually involving a significant change in the properties of the pipe. The phenomena also differ according to the external and internal stresses affecting the pipes conveying the products (e.g. temperature, pressure, wall thickness).

By stresses are meant those forces caused by internal or external factors such as temperature, variation of temperature, inside pressure, bending, internal stresses. Internal stresses could be caused, for instance, by fast quenching of thick-walled pipes.

As the conditions of use vary a great deal, it is important to carry out a preliminary determination of the chemical resistance of thermoplastics pipes by means of simple, straightforward tests.

The purpose of this International Standard is to provide a procedure for the experimental test methods.

Some liquids (e.g. wetting agents) may cause cracking in specimens subject to tensile stress, whilst not affecting the properties of specimens not under stress. The strip bending test as specified in ISO 4599[3] (see annex C) or the constant tensile stress method as specified in ISO 6252[4] will give an indication of the susceptibility of the material to stress cracking. For polyolefin materials, attention is also drawn to ISO 13480[7].

The extrapolation of the results obtained with this method, expressed as:

satisfactory resistance	S
limited resistance	L
non-satisfactory resistance	NS

for any kind of pipe or fitting may be made only when high internal stresses are not induced in the pipe.

In order to assess the behaviour of pipes and fittings for the conveyance of liquids under pressure or in the presence of other stresses, in cases when the preliminary classification is S or L, it will be necessary to carry out further tests as specified in ISO 8584-1[5].

NOTES

1 This International Standard is also applicable to thermoplastics sheet as appropriate.

2 A collection of results obtained by this method for several types of plastics is contained in ISO/TR 10358.

[www.parsethylene-kish.com](http://www.parsethylene-kish.com)

# Thermoplastics pipes — Resistance to liquid chemicals — Classification —

## Part 1: Immersion test method

### 1 Scope

1.1 This part of ISO 4433 specifies a method for carrying out a preliminary evaluation of the behaviour of thermoplastics pipes in relation to the liquid chemicals transported.

1.2 This method of classification provides information on the suitability of pipes for transporting liquid chemicals in the absence of pressure or stresses such as earth loads, dynamic stresses and internal stresses.

1.3 A full procedure for carrying out the test is also reported in ISO 175, which is devoted to plastics in general, and not specifically to thermoplastics pipes.

### 2 Normative references

The following standards contain provisions which, through reference in this text, constitute provisions of this part of ISO 4433. At the time of publication, the editions indicated were valid. All standards are subject to revision, and parties to agreements based on this part of ISO 4433 are encouraged to investigate the possibility of applying the most recent editions of the standards indicated below. Members of IEC and ISO maintain registers of currently valid International Standards.

ISO 175:1981, *Plastics — Determination of the effects of liquid chemicals, including water.*

ISO 527-2:1993, *Plastics — Determination of tensile properties — Part 2: Test conditions for moulding and extrusion plastics.*

ISO 5893:1993, *Rubber and plastics test equipment — Tensile, flexural and compression types (constant rate of traverse) — Description.*

ISO 6259-2:—<sup>1</sup>, *Thermoplastics pipes — Determination of tensile properties — Part 2: Pipes made of unplasticized poly(vinyl chloride) (PVC-U), chlorinated poly(vinyl chloride) (PVC-C) and high-impact poly(vinyl chloride) (PVC-HI).*

ISO 6259-3:—<sup>1</sup>, *Thermoplastics pipes — Determination of tensile properties — Part 3: Polyolefin pipes.*

1) To be published.

### 3 Principle

**3.1** Standard test pieces (of the type used for tensile tests — see figure 1) are taken from pipes, of wall thickness preferably between 1,8 mm and 3,2 mm, made from the material to be tested (see ISO 527-2).

**3.2** The test pieces are completely immersed in the liquid chemical being used for the test.

**3.3** The immersion periods are standardized and chosen according to the change in mass of the test pieces as a function of time, in particular to the state of saturation or equilibrium as indicated by a plateau in the curve of change in mass.

NOTE — Additional information is required when

- the pipes are permeable to the liquids transported;
- electrostatic surface charges present a risk (liquids with a flash point of less than 55 °C; the flash point can be determined by ISO 15161<sup>[1]</sup> or ISO 3680<sup>[2]</sup>);
- the immersion liquid can produce particular effects, such as stress cracking phenomena, which this method does not cover.

### 4 Materials

#### 4.1 Test liquids

**4.1.1** When information is required on the behaviour of a thermoplastic pipe used to transport a specific liquid, this liquid shall normally be used.

**4.1.2** The composition of industrial liquids is not, in general, absolutely constant; whenever possible, therefore, the test shall be carried out in defined chemical liquids used on their own or in mixtures, and so that it is as representative as possible of the action of the products in question.

**4.1.3** The volume of liquid required for one immersion temperature shall be about 10 l.

#### 4.2 Auxiliary materials

**4.2.1** Filter paper or similar material, for drying the test pieces.

**4.2.2** Petroleum ether or ethanol, for cleaning specimens.

### 5 Apparatus

**5.1** Containers, with a cover or stopper, to hold the test liquid in cases where its vapour pressure is negligible at the immersion temperature, or containers with a reflux condenser or containers that can be sealed (e.g. autoclaves) for liquids which are volatile at the immersion temperature.

**5.2** Controlled atmosphere enclosure, constant-temperature bath or oven, capable of maintaining the containers at the required temperature to within  $\pm 2$  °C.

**5.3** Balance, with a limit of error of 1 mg.

**5.4** Tall-form weighing bottle.

**5.5 Micrometer or its equivalent**, for measuring the test piece thickness and width to an accuracy of 0,02 mm.

**5.6 Tensile-testing machine**, with test speeds of 1 mm/min, 25 mm/min and 100 mm/min, an **extensometer** accurate to  $\pm 2,5\%$  and a **clamping device**. The load capability and measurement accuracy shall be in accordance with ISO 5893.

The load and elongation data shall be obtained as automatically recorded curves or by direct observation.

## 6 Test pieces

### 6.1 Shape and dimensions

The shape and dimensions of the test piece shall be as given in figure 1.

NOTE — This test piece is half the size of the type 1B test piece specified in ISO 527-2.

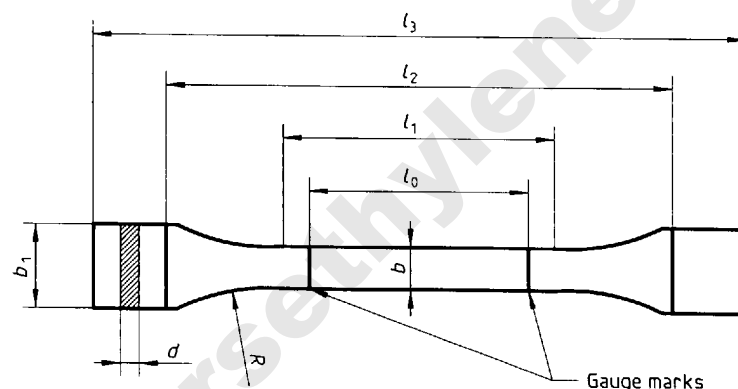

<i>b</i>	Width of narrow parallel-sided portion:	5 mm $\pm$ 0,5 mm
<i>b</i> <sub>1</sub>	Width at ends:	10 mm $\pm$ 0,5 mm
<i>d</i>	Thickness:	see ISO 6259-2 and ISO 6259-3
<i>l</i> <sub>0</sub>	Distance between gauge marks:	25 mm $\pm$ 0,5 mm
<i>l</i> <sub>1</sub>	Length of narrow parallel-sided portion:	30 mm $\pm$ 0,5 mm
<i>l</i> <sub>2</sub>	Initial distance between grips:	60 mm $\pm$ 5 mm
<i>l</i> <sub>3</sub>	Overall length, min.:	75 mm
<i>R</i>	Radius, min.:	30 mm

Figure 1 — Test piece

## 6.2 Number of test pieces

The minimum number of test pieces to be prepared shall be 20 for each test liquid at each temperature.

## 6.3 Preparation of test pieces

The pipes used for providing test pieces shall conform to the following conditions:

- they shall have been extruded at least 3 days previously except for polybutylene (PB) for which the extrusion shall have been at least 10 days previously;
- they shall conform to the applicable specifications for thermoplastics pipes;
- the pipe shall have a wall thickness between 1,8 mm and 3,2 mm, preferably  $2,2 \text{ mm} \pm 0,3 \text{ mm}$ , and an outside diameter preferably from 75 mm to 110 mm.

Test pieces shall be prepared in such a way that their axis is parallel to that of the pipe and shall be taken regularly from around its circumference.

## 6.4 Conditioning of test pieces before testing

The immersion test and the tests on the non-immersed test pieces shall not be carried out until the test pieces have been kept at  $23 \text{ °C} \pm 2 \text{ °C}$  and  $(50 \pm 5) \%$  relative humidity for a minimum of 24 h.

## 7 Immersion procedure

### 7.1 General

Use the general test procedure given in ISO 175 with the following more detailed requirements.

### 7.2 Number and intended use of test pieces

- a) use one set of at least five test pieces to determine the initial tensile properties;
- b) use three sets of at least five test pieces to determine the change in mass and the change in tensile properties after immersion times  $t_1$ ,  $t_2$  and  $t_3$  as defined in 7.5;
- c) use additional test pieces as necessary to determine the initial immersion time (see 7.5).

### 7.3 Steps to be taken before every immersion

Immediately before immersion, measure the width and thickness of the gauge length to the nearest 0,02 mm and mark the test piece clearly to prevent any confusion.

### 7.4 Test temperature

Maintain the test liquid by suitable means at one of the temperatures indicated by a cross in table 1.



Table 1 — Test temperatures

Material	Immersion temperature °C				
	23 ± 2	40 ± 2	60 ± 2	80 ± 2	100 ± 2
PE (LD, MD, HD)	x	x	x	x	—
PP	x	x	x	x	x
PB	x	x	x	x	x
PE-X	x	x	x	x	x
ABS	x	x	x	—	—
PVC (U; HI)	x	x	x	—	—
PVC-C	x	x	x	x	—
PVDF	x	x	x	x	x

If the boiling point of a test liquid lies below a temperature given in table 1, the test shall be carried out at the boiling point of the liquid.

NOTE — These test temperatures are the standard ones. Other test temperatures may be used, depending on the service temperature in the envisaged application and on the physical capability of the material tested.

### 7.5 Duration of immersion

To determine the initial time for the determination of the tensile properties, remove immersed test pieces from the liquid for tensile tests after three consecutive immersion periods  $t_1$ ,  $t_2$  and  $t_3$  chosen from the following:

7 d      14 d      28 d      56 d      112 d

The initial time is normally given by the appearance of a plateau in the curve showing the change in mass as a function of time (see clause 8), but shall not exceed 28 d even if no plateau appears in the change in mass curve before 28 d. The plateau in the change in mass curve indicates that saturation or equilibrium has been reached (see curves No. 4 and No. 7 in annex B. If saturation or equilibrium is not reached after 112 days, continue the immersion test until a plateau is reached, or end the test with a classification of NS (not suitable).

### 7.6 Quantity of liquid used

Generally speaking (i.e. in the case of pipes not containing extractable products or products very prone to attack), use at least 4 ml of liquid per cm<sup>2</sup> of total test piece area or at least 60 ml per test piece, whichever is the greater.

#### NOTES

- 1 The total area of a half-size type 1B test piece 2,2 mm thick is approximately 15 cm<sup>2</sup>.
- 2 For each test piece to be immersed in a minimum of 60 ml, 0,9 l of liquid are required for a set of 15 test pieces.

### 7.7 Positioning of test pieces

Immerse the test pieces under the following conditions and record the time when the immersion began:

- a) if the test pieces are identical, several test pieces may be placed in the same container as long as they do not touch each other;

- b) the area of the test piece in contact with the walls of the container shall be as small as possible, for example by having one edge resting on the bottom of the container and the other on the vertical wall, or by suspending the test pieces;
- c) if the circumstances warrant it, the containers shall be covered or stoppered and placed in a thermostatically controlled enclosure.

NOTE — If there is any possibility of light affecting the action of the liquid, it is recommended that the immersed test pieces are kept in darkness or under defined conditions of illumination.

## 7.8 Replacing the test liquid

During the immersion, stir the liquid once a day and replace it every 7 days. If the liquid is unstable (for example sodium hypochlorite), replace it more frequently.

## 7.9 Rinsing and drying the test pieces

At the end of the immersion period, bring each test piece to ambient temperature by transferring it to test liquid at the temperature of the laboratory and keeping it at this temperature for  $3 \text{ h} \pm 1 \text{ h}$ .

Remove the test piece from the liquid and rinse and dry it as follows:

- a) if the liquid is an acid, a base or an aqueous solution, rinse the test piece rapidly in water and dry it with a filter paper or a cloth which does not shed fluff;
- b) if the liquid is a non-volatile organic liquid insoluble in water, rinse the test piece with an inert but volatile solvent such as petroleum ether or ethanol and dry it rapidly;
- c) if the liquid is a volatile solvent, dry the test piece rapidly.

## 8 Determination of the change in mass as a function of the immersion period

NOTE — The main purpose of this determination is to determine the times after which the tensile tests should be conducted. It is carried out on one of the three sets of immersed test pieces, each element of which shall be clearly marked.

### 8.1 Procedure

**8.1.1** Determine the mass  $m_1$  of each test piece to the nearest milligram prior to immersion.

**8.1.2** Select the test liquid in accordance with clause 4 and the temperature in accordance with 7.4.

**8.1.3** Immerse the test pieces as described in clause 7.

**8.1.4** At the end of the immersion period (see 7.5), place each rinsed and dried test piece in a tared weighing bottle, stopper it and determine the mass  $m_2$  of the test piece after immersion to the nearest milligram. If the liquid used for the test is very volatile at ambient temperature, the period during which the test piece is exposed to the atmosphere shall not exceed 30 s.

**8.1.5** Re-immerses the test piece in the liquid as soon as weighing is completed.

### 8.2 Frequency of measurement

The change in mass shall be determined on test pieces taken out of the liquid after immersion for 24 h, 3 d, 7 d, 14 d, 28 d and, if necessary, 56 d and 112 d.

### 8.3 Calculation of the percentage change in mass

**8.3.1** Calculate the percentage increase (or decrease) in mass  $\Delta m$  for each test piece, using the following equation:

$$\Delta m = \frac{m_2 - m_1}{m_1} \times 100$$

where

$m_1$  is the initial mass of the test piece (before immersion);

$m_2$  is the mass of the test piece after immersion.

**8.3.2** Calculate the arithmetic mean  $\overline{\Delta m}$  of the results for the test pieces from the same pipe sample and for the same period of immersion at the same temperature.

### 8.4 Graphical expression of results

After each set of determinations, record the results in the form of graph, plotting  $\Delta m$  as a function of the square root of the time (an example of a suitable format is shown in annex A).

### 8.5 Application of the results

The curve showing the variation in mass as a function of time can have various forms, the most common of which are shown diagrammatically in annex B.

When a curve of the No. 4 or No. 7 type is obtained having a plateau, it is possible to identify the time  $t_1$  after which the subsequent change in mass is negligible. The tensile tests defined in clause 9 are then carried out using  $t_1$  days as the initial immersion time, which represents the time to saturation or equilibrium, and can be 7 d, 14 d or 28 d.

If the curve obtained is one of the other types (1, 2, 3, 5 or 6), the time  $t_1$  shall be 28 d.

## 9 Determination of changes in tensile properties

### 9.1 General

See ISO 527-2.

### 9.2 Conditioning of test pieces

The determination of the tensile properties shall be carried out on sets of at least five test pieces which have been treated in the same way: either no immersion in the case of the original values, or immersion in the same liquid for the same period and at the same temperature in the case of the values after immersion.

When the test pieces have been immersed at a temperature above 23 °C, they shall be conditioned for 3 h at 23° C ± 2 °C in the same test liquid before being submitted to the tensile tests.

Otherwise, the test pieces shall be tested not later than 2 h after their removal from the liquid, and during this period they shall be kept at 23 °C ± 2 °C.

If the liquid used for the test is very volatile at ambient temperature, the test shall be commenced within 2 min to 3 min after the removal of the test piece from the liquid.

### 9.3 Test speed

The test speed, i.e. the speed of separation of the grips of the apparatus during measurement, shall be as follows:

- a) for the determination of elastic modulus: 1 mm/min;
- b) for the determination of other tensile properties: the speed given in table 2 for the material concerned, unless otherwise agreed upon.

For tests a) and b), different sets of test pieces shall be used.

NOTE — Tests may be carried out using one set of test pieces by starting at the lower speed (1 mm/min) for the determination of the elastic modulus and subsequently increasing the test speed to that given in table 2. In cases of dispute, two different sets of test pieces shall be used.

Table 2 — Test speed for properties other than elastic modulus

Material	Speed mm/min
PE (LD, MD, HD)	100
PP	100
PB	100
PE-X	100
ABS	100
PVC-U	25
PVC-HI	25
PVC-C	25
PVDF	25

### 9.4 Procedure

Carry out the tests at  $23\text{ °C} \pm 2\text{ °C}$ , using the tensile-testing machine (5.6).

Place the test piece in the grips of the machine.

Set the extension indicator to indicate a distance of  $25\text{ mm} \pm 0,5\text{ mm}$  between the grips.

Set the test speed to the speed given in table 2 for the material to be tested, or to a speed of 1 mm/min for the determination of the elastic modulus.

Start the machine.

Record the following details:

- a) the load  $F_1$  at an elongation of 0,05 %;
- b) the load  $F_2$  at an elongation of 0,25 %;
- c) the existence of a yield point causing necking;
- d) the load  $F_y$  or  $F_{y0}$  at the yield point (where the suffix 0 relates to the original value, i.e. before immersion);

- e) the elongation  $\varepsilon_y$  or  $\varepsilon_{y0}$  at the yield point;
- f) the load  $F_b$  at break and the elongation  $\varepsilon_b$  at break if there is a wide scatter of the values of elongation at yield (the elongation at break can be taken as the distance between the grips at break).

### 9.5 Calculation of elastic modulus

For each test piece, calculate the elastic modulus  $E_t$  using the following equations:

$$E_t = \frac{\sigma_2 - \sigma_1}{\varepsilon_2 - \varepsilon_1}$$

$$\sigma = F/A_0$$

$$\varepsilon = \Delta l/l_0$$

where

- $\sigma_1$  is the stress, in megapascals, at 0,05 % elongation;
- $\sigma_2$  is the stress, in megapascals, at 0,25 % elongation;
- $\varepsilon_1$  is the elongation of 0,05 % expressed as the ratio  $\Delta l/l_0$ ;
- $\varepsilon_2$  is the elongation of 0,25 % expressed as the ratio  $\Delta l/l_0$ ;
- $F$  is the force, in newtons;
- $A_0$  is the initial cross-section, in square millimetres;
- $\Delta l$  is the change in length, in millimetres, produced by the force  $F$ ;
- $l_0$  is the initial gauge length, in millimetres.

### 9.6 Calculation of the strength at yield and at break

For each test piece, calculate the strength at yield and the strength at break using the following equations, where  $F_y$  may be replaced by  $F_{y0}$  [see item d) in 9.4]:

$$\sigma_y = \frac{F_y}{b \times d}$$

$$\sigma_b = \frac{F_b}{b \times d}$$

where

- $\sigma_y$  is the strength at yield, in megapascals;
- $\sigma_b$  is the strength at break, in megapascals;
- $F_y$  is the load at yield, in newtons;
- $F_b$  is the load at break, in newtons;
- $b$  is the initial width of the test piece, in millimetres;
- $d$  is the initial thickness of the test piece, in millimetres.

Express the results to three significant figures.

## 9.7 Calculation of elongation at yield and at break

For each test piece, calculate the elongation at yield and at break using the following equations, where  $\varepsilon_y$  may be replaced by  $\varepsilon_{y0}$  [see item e) in 9.4]:

$$\varepsilon_y = \frac{l_y - l_0}{l_0} \times 100$$

$$\varepsilon_b = \frac{l_b - l_0}{l_0} \times 100$$

where

- $\varepsilon_y$  is the elongation at yield, expressed as a percentage;
- $\varepsilon_b$  is the elongation at break, expressed as a percentage;
- $l_y$  is the gauge length of the test piece at yield, in millimetres;
- $l_0$  is the initial gauge length of the test piece, in millimetres;
- $l_b$  is the gauge length of the test piece at break, in millimetres.

Express the results to three significant figures.

## 10 Test report

The test report shall include the following information:

- a) a reference to this part of ISO 4433;
- b) all details necessary for complete identification of the pipe tested, including material, trade name, dimensions;
- c) all details necessary for identification of the immersion liquid used, including type, concentration, composition;
- d) the immersion temperature, in degrees Celsius;
- e) the immersion period, in days;
- f) the percentage change in mass (individual values and mean);
- g) the elastic modulus;
- h) the values of the tensile properties (strength at yield and at break, elongation at yield and at break) (individual values and mean);
- i) any agreed deviations from this part of ISO 4433;
- j) the test laboratory;
- k) the date of the test.

### Annex A (informative)

#### Example of a suitable format for the change in mass plot

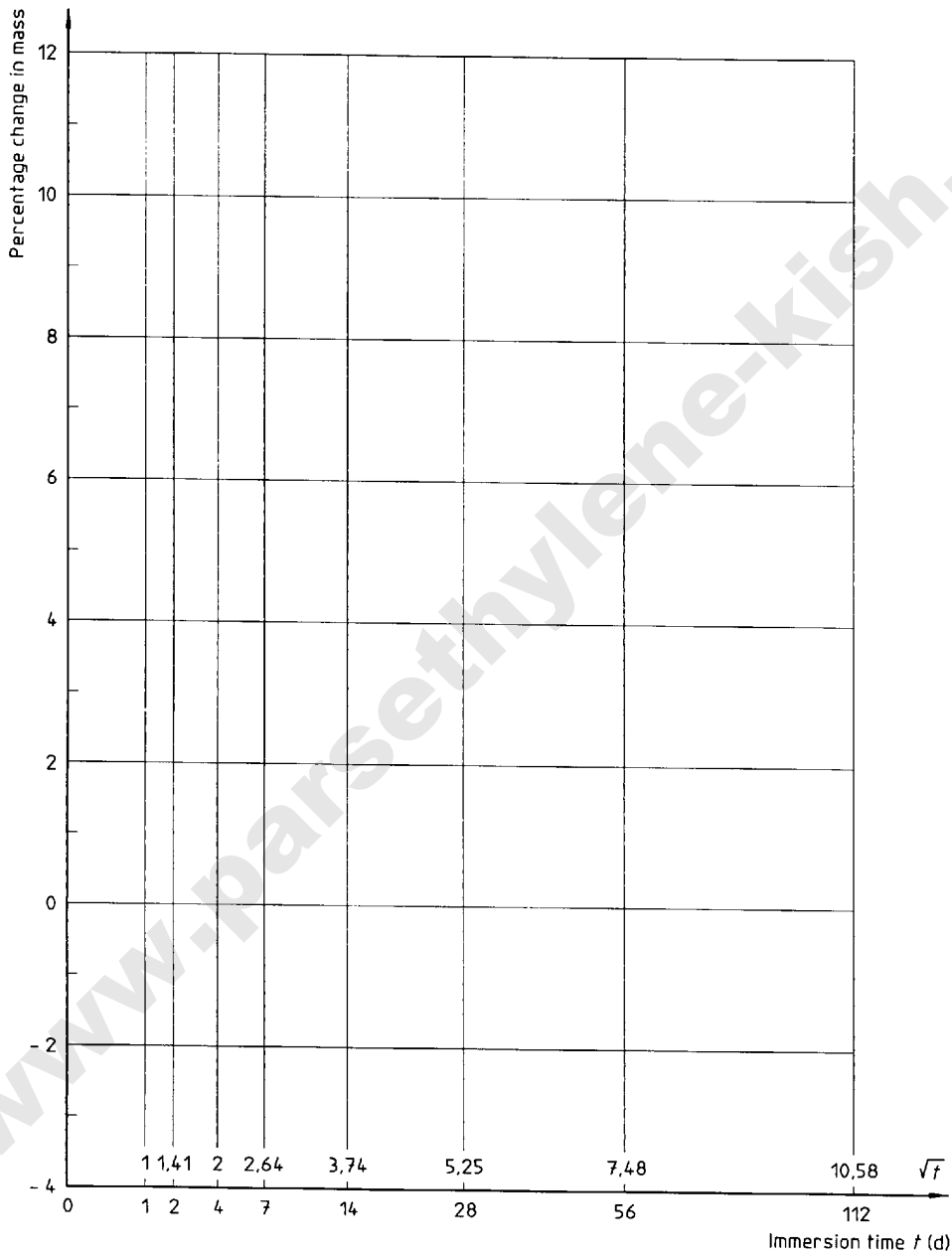

**Annex B**  
(informative)

**Change in mass with time of immersion — Types of curve**

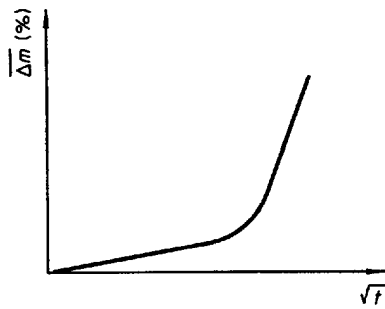

Curve No. 1

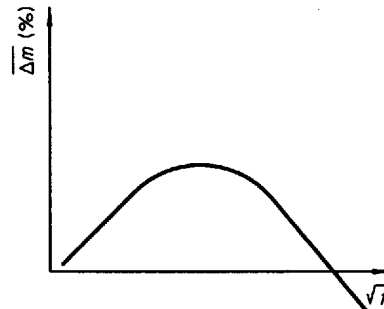

Curve No. 2

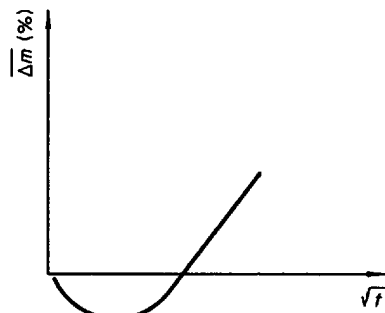

Curve No. 3

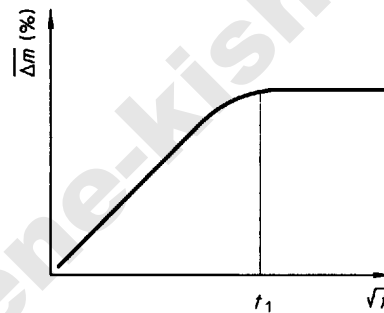

Curve No. 4

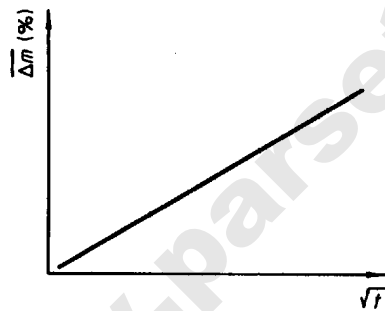

Curve No. 5

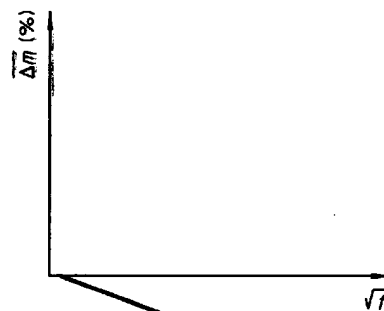

Curve No. 6

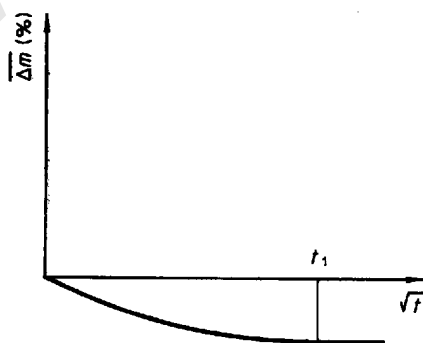

Curve No. 7



## Annex C (informative)

### Bibliography

- [1] ISO 1516:1981, *Paints, varnishes, petroleum and related products — Flash/no flash test — Closed cup equilibrium method.*
- [2] ISO 3680:1983, *Paints, varnishes, petroleum and related products — Flash/no flash test — Rapid equilibrium method.*
- [3] ISO 4599:1986, *Plastics — Determination of resistance to environmental stress cracking (ESC) — Bent strip method.*
- [4] ISO 6252:1992, *Plastics — Determination of environmental stress cracking (ESC) — Constant-tensile-stress method.*
- [5] ISO 8584-1:1990, *Thermoplastics pipes for industrial applications under pressure — Determination of the chemical resistance factor and of the basic stress — Part 1: Polyolefin pipes.*
- [6] ISO/TR 10358:1993, *Plastics pipes and fittings — Combined chemical-resistance classification table.*
- [7] ISO 13480, *Polyethylene pipes — Resistance to slow crack growth — Cone test method.*

[www.parsethylene-kish.com](http://www.parsethylene-kish.com)

---

**ICS 23.040.20**

**Descriptors:** pipes (tubes), thermoplastic resins, plastic tubes, tests, immersion tests, determination, chemical resistance, classification.

Price based on 13 pages

---