

Elbow 45

d	Code	Z	L*	e	
				SDR17	SDR11
63	F3-063-045	95	60	3.8	5.8
75	F3-075-045	100	60	4.5	6.8
90	F3-090-045	120	80	5.4	8.2
110	F3-110-045	100	63	6.6	10
125	F3-125-045	140	88	7.4	11.4
160	F3-160-045	150	90	9.5	14.6
200	F3-200-045	185	113	11.9	18.2
250	F3-250-045	215	130	14.8	22.7
315	F3-315-045	256	177	18.7	28.6

* امکان تولید به صورت فلنجدار با فلنج تزریقی میسر میباشد

• جداره تقویت شده با قابلیت جوش قطعات الکتروفیوژن

Office Address:

No.8 (Suit 6), Nour Alley, Africa St., Tehran/IRAN.....

Tel.: (+98 21) 88 67 79 65 , 88 67 79 66, 88 67 39 19 , 88 67 39 18 - Fax: (+98 21) 88 87 85 81



PARS ETHYLENE KISH CO.

WE TAKE CARE ABOUT THE FUTURE

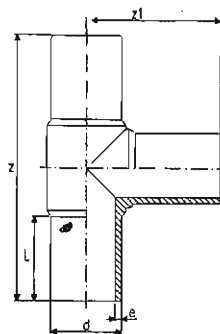

Tee 90 Equal

d	Code	Z	Z1	L*	e	
					SDR17	SDR11
63	F3-063-063	230	115	65	3.8	5.8
75	F3-075-075	264	132	72	4.5	6.8
90	F3-090-090	300	150	80	5.4	8.2
110	F3-110-110	295	140	60	6.6	10
125	F3-125-125	365	180	90	7.4	11.4
160	F3-160-160	425	210	100	9.5	14.6
180	F3-180-180	515	260	125	10.5	16.4
200	F3-200-200	515	260	125	11.9	18.2
225	F3-225-225	540	270	125	13.4	20.5
250	F3-250-250	510	255	100	14.8	22.7
280	F3-280-280	595	298	96	16.6	25.4
315	F3-315-315	595	298	94	18.7	28.6
355	F3-355-355	656	328	120	21.1	32.2
400	F3-400-400	725	362	130	23.7	36.3

* امکان تولید به صورت فلنجدار با فلنج تزریقی میسر میباشد

Office Address:

No.8 (Suit 6), Nour Alley, Africa St., Tehran/IRAN.....

Tel.: (+98 21) 88 67 79 65 , 88 67 79 66, 88 67 39 19 , 88 67 39 18 - Fax: (+98 21) 88 87 85 81

www.parsethylene-kish.com



PARS ETHYLENE KISH CO.

WE TAKE CARE ABOUT THE FUTURE

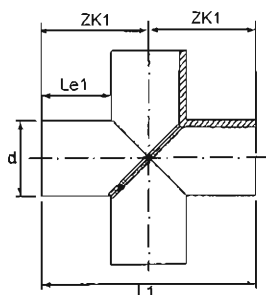

Cross 90

D		CODE	L1*	L2	LT	ZK1
125	Injection	H4-090-090	81	101	300	150
110	Injection	H4-110-110	86	106	330	165
125	-	H4-125-125	-	150	430	215
140	-	H4-140-140	-	150	440	220
160	Injection	H4-160-160	102	125	420	210
180	-	H4-180-180	-	150	480	440
200	Injection	H4-200-200	117	145	500	250
225	-	H4-225-225	-	150	530	265
250	Injection	H4-250-250	148	180	620	310
315	-	H4-315-315	-	300	920	460
355	-	H4-355-355	-	300	960	480
400	-	H4-400-400	-	300	1000	500
450	-	H4-450-450	-	300	1050	525
500	-	H4-500-500	-	350	1200	600
560	-	H4-560-560	-	350	1260	630
630	-	H4-630-630	-	350	1330	665
710	-	H4-710-710	-	350	1410	705
800	-	H4-800-800	-	350	1500	750
900	-	H4-900-900	-	400	1700	850

Office Address:

• جداره تقویت شده با قابلیت جوش قطعات الکتروفیوژن

No.8 (Suit 6), Nour Alley, Africa St., Tehran/IRAN.....

Tel.: (+98 21) 88 67 79 65 , 88 67 79 66, 88 67 39 19 , 88 67 39 18 - Fax: (+98 21) 88 87 85 81

www.parsethylene-kish.com

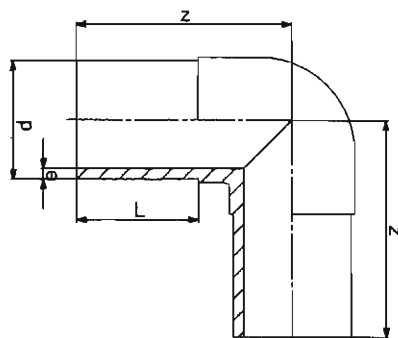

Elbow 90

d	Code	z	L*	e	
				SDR17	SDR11
63	F2-063-090	110	60	3.8	5.8
75	F2-075-090	120	60	4.5	6.8
90	F2-090-090	150	80	5.4	8.2
110	F2-110-090	140	68	6.6	10
125	F2-125-090	180	90	7.4	11.4
160	F2-160-090	210	-	9.5	14.6
180	F2-180-090	170	170	10.7	16.4
200	F2-200-090	255	-	11.9	18.2
* 250	F2-250-090	245	95	14.8	22.7
* 315	F2-315-090	310	120	18.7	28.6
* 400	F2-400-090	362	130	23.7	36.3

* امکان تولید به صورت فلنجدار با فلنج تزریقی میسر میباشد
• جداره تقویت شده با قابلیت جوش قطعات الکتروفیوژن

Office Address:

No.8 (Suit 6), Nour Alley, Africa St., Tehran/IRAN.....

Tel.: (+98 21) 88 67 79 65 , 88 67 79 66, 88 67 39 19 , 88 67 39 18 - Fax: (+98 21) 88 87 85 81

www.parsethylene-kish.com



Reduced Tee 90

d-d1	Code	Z	Z1	L*	L1*	SDR17		SDR11	
						e	e1	e	e1
63*50	F3-063-050	215	103	60	50	3.8	3	5.8	4.6
75*50	F3-075-050	255	108	70	50	4.5	3	6.8	4.6
75*63	F3-075-063	255	117	70	60	4.5	3.8	6.8	5.8
90*63	F3-090-063	269	136	73	60	5.4	3.8	8.2	5.8
90*75	F3-090-075	272	138	73	70	5.4	4.5	8.2	6.8
110*63	F3-110-063	295	140	63	75	6.6	3.8	10	5.8
110*75	F3-110-075	295	140	63	73	6.6	4.5	10	6.8
110*90	F3-110-090	295	140	63	73	6.6	5.4	10	8.2
125*90	F3-125-090	335	170	90	73	7.4	5.4	11.4	8.2
125*110	F3-125-110	340	170	90	82	7.4	6.6	11.4	10
160*63	F3-160-063	420	210	100	65	9.5	3.8	14.6	5.8
160*75	F3-160-075	420	210	100	65	9.5	4.5	14.6	6.8
160*90	F3-160-090	420	210	100	65	9.5	5.4	14.6	8.2
160*110	F3-160-110	420	210	100	70	9.5	6.6	14.6	10
180*63	F3-180-063	420	202	100	60	10.7	3.8	16.4	5.8
180*75	F3-180-075	420	202	100	70	10.7	4.5	16.4	6.8
180*90	F3-180-090	420	202	100	73	10.7	5.4	16.4	8.2
180*110	F3-180-110	430	205	100	82	10.7	6.6	16.4	10
20*63	F3-200-063	490	245	117	60	11.9	3.8	18.2	5.8
200*75	F3-200-075	510	235	120	65	11.9	4.5	18.2	6.8
200*90	F3-200-090	515	255	125	115	11.9	5.4	18.2	8.2
200*110	F3-200-110	515	265	125	135	11.9	6.6	18.2	10
200*160	F3-200-160	515	265	125	95	11.9	9.5	18.2	14.6
250*90	F3-250-090	510	265	100	80	14.8	5.4	22.7	8.2
250*110	F3-250-110	510	265	100	85	14.8	6.6	22.7	10
250*125	F3-250-125	510	265	100	90	14.8	7.4	22.7	11.4
250*160	F3-250-160	510	265	100	95	14.8	9.5	22.7	14.6
250*200	F3-250-200	510	265	100	113	14.8	11.9	22.7	18.2
315*110	F3-315-110	520	225	100	82	18.7	6.6	28.6	10
315*125	F3-315-125	520	255	100	100	18.7	7.4	28.6	11.4
315*160	F3-315-160	595	298	94	95	18.7	9.5	28.6	14.6
315*200	F3-315-200	595	298	94	86	18.7	11.9	28.6	18.2
315*250	F3-315-250	595	298	94	86	18.7	14.8	28.6	22.7
355*110	F3-355-110	656	288	120	86	21.2	6.6	32.3	10
355*160	F3-355-160	656	308	120	102	21.2	9.5	32.3	14.6
355*200	F3-355-200	656	328	120	117	21.2	12	32.3	18.2
355*250	F3-355-250	656	328	120	120	21.2	14.8	32.3	22.7
400*160	F3-400-160	750	362	130	130	23.7	9.5	36.3	14.6
400*200	F3-400-200	750	362	130	130	23.7	11.9	36.3	18.2
400*250	F3-400-250	750	362	130	130	23.7	14.8	36.3	22.7
400*315	F3-400-315	750	362	130	130	23.7	18.7	36.3	28.6

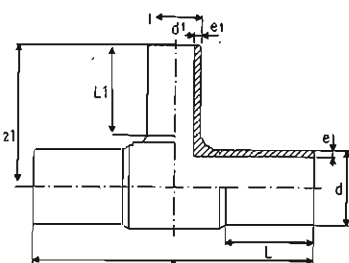

Office Address:

No.8 (Suit 6), Nour Alley, Africa St., Tehran/IRAN.....

Tel.: (+98 21) 88 67 79 65 , 88 67 79 66, 88 67 39 19 , 88 67 39 18 - Fax: (+98 21) 88 87 85 81

www.parsethylene-kish.com

• جداره تقویت شده با قابلیت جوش قطعات الکترونیوزن

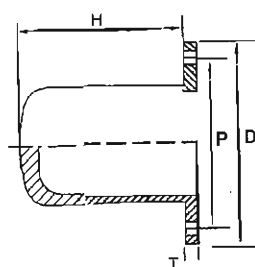
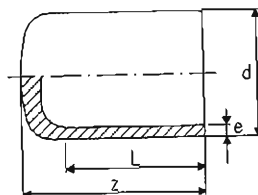

Cap

d	Code	Z	L	e		D	P	H	T*
				SDR17	SDR11				
50	F6-050-000	63	63	3	4.6	150	110	63	18
63	F6-063-000	62	52	3.8	5.8	165	125	70	17
75	F6-075-000	75	60	4.5	6.8	185	145	84	17
90	F6-090-000	86	70	5.4	8.2	200	160	95	16
110	F6-110-000	95	76	6.6	10	220	180	100	21
125	F6-125-000	100	85	7.4	11.4	250	210	110	21
160	F6-160-000	115	93	9.5	14.6	285	240	126	23
200	F6-200-000	133	103	11.9	18.2	340	295	145	22

• رواداری استاندارد به میزان ± 2 میلی متر میباشد.

Office Address:

No.8 (Suit 6), Nour Alley, Africa St., Tehran/IRAN.....

Tel.: (+98 21) 88 67 79 65 , 88 67 79 66, 88 67 39 19 , 88 67 39 18 - Fax: (+98 21) 88 87 85 81

www.parsethylene-kish.com

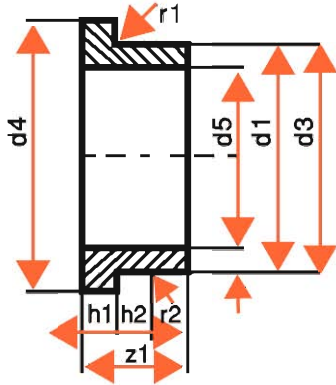

Short Stub End for PFCP Gasket

Ext diam pipe d1	d3	d4	2) d5 PE 63						3) h1			h2	r1	r2 min.	4) Z1
			PN 3,2	PN 4	PN 6	PN 10	PN 12,5	PN 16	PN 3,2 PN 4	PN 6 PN 10	PN 12,5 PN 16				
20	27	45	-	-	-	15,1	15,1	14,1	-	7	7				
25	33	58	-	-	20,1	20,1	19,1	17,6	-	9	9	13	3	20	100
32	40	1) 64	-	-	27,1	25,9	24,4	22,7	-	10	10				
40	50	78	-	35,1	35,1	32,2	30,5	28,3	11	11	18	15	3		
50	61	88	-	45,2	44,0	40,4	38,2	35,4	12	12	19	15	3	20	100
63	75	102	58,2	57,8	55,5	50,8	48,0	44,8	14	14	21	20	4		
75	89	122	70,3	69,1	66,1	60,7	57,3	53,2	16	16	23	20			100
90	105	1) 132	84,4	82,9	79,5	72,8	68,7	64,0	17	17	24	20	4	20	130
110	125	158	103,1	101,4	96,9	89,0	84,0	78,0	18	18	26	25			130
125	132	158	117,2	115,2	110,3	101,0	95,5	88,0			33	20			
140	155	188	131,4	129,0	123,5	113,3	106,9	98,5	18	25	33	28	4	20	130
160	175	212	150,2	147,4	141,2	129,4	121,5	112,7			45	28			
180	1) 188	212	169,0	166,0	158,9	144,9	136,7	126,8		30	50	30			130
200	232	268	187,5	184,3	176,3	160,9	151,7	140,7	18	32	52	40	4	20	150
225	235	268	211,2	207,6	198,5	181,1	170,7	158,4		32	52	30			150
250	285	320	234,6	230,5	220,6	201,3	189,9	176,0				40			
280	291	320	262,8	258,2	247,1	225,5	212,5	197,1	20	35	65	30	4	20	150
315	335	370	295,6	290,4	277,2	253,6	239,1	221,7				40			
355	373	430	333,1	327,3	312,4	285,8	269,3	250,0	23	40	65	40			
400	427	482	375,3	368,9	351,9	322,0	303,5	281,5	26	46	65	45	6	20	170
450	1) 482	1) 545	422,4	414,3	396,1	362,2	341,5	316,9	38	60	70	60			
500	530	585	469,4	460,3	440,1	402,5	379,6	-	38		70	50			
560	615	1) 656	524,7	515,5	492,8	450,8	-	-	40	60	-	60	6	20	170
630	642	685	590,5	579,9	554,4	507,1	-	-	40		-	40			
710	737	800	665,3	653,4	624,8	-	-	-	40	50	-	50			170
800	840	905	749,8	736,3	704,0	-	-	-	42	52	-	50	8	20	170
900	944	1005	843,4	828,5	792,0	-	-	-	46	55	-	50			170
1000	1047	1110	937,2	920,5	880,0	-	-	-	50	60	-	70			190
1200	1245	1330	1124,3	1104,1	-	-	-	-	60	-	-	70			190

1) DIN 16963 norm part 4.

3) The H1 values correspond to those of higher PN.

2) D5 considers average values, ISO 11922-1 norm.

4) Z1 corresponds to Z1 min. Plus 50mm.

Office Address:

No.8 (Suit 6), Nour Alley, Africa St., Tehran/IRAN.....

Tel.: (+98 21) 88 67 79 65 , 88 67 79 66, 88 67 39 19 , 88 67 39 18 - Fax: (+98 21) 88 87 85 81

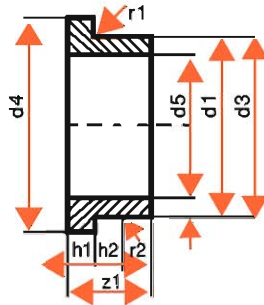

Short Stub End for PFCP Gasket (PE 100)

Ext diam pipe d1	d3	d4	2) d5 PE 100					3) h1		h2	r1	r2 min.	4) z1	
			PN6	PN10	PN 12.5	PN16	PN20	PN6 PN10	PN12.5 PN16 PN20					
20	27	45	-	-	-	-	-	-	-	-	-	-	-	
25	33	58	-	-	-	-	-	-	-	-	-	-	-	
32	40	1) 64	-	-	26.9	25.7	24.4	-	10	13	3	20	100	
40	50	78	-	34.9	33.7	32.2	30.5	11	18	15	3	20	100	
50	61	88	-	43.8	42.3	40.4	38.2	12	19	15	3	20	100	
63	75	102	-	55.1	53.1	50.8	48.0	14	21	20	4	20	100	
75	83	122	-	65.7	63.3	60.7	57.3	16	23	20	4	20	130	
90	105	1) 132	-	78.8	76.0	72.8	68.7	17	24	20	4	20	130	
110	125	158	-	96.3	93.0	89.0	84.0	18	26	25	4	20	130	
125	132	158	-	109.6	105.8	101.0	95.5	-	33	20	4	20	130	
140	155	188	-	122.8	118.5	113.3	106.9	25	33	28	4	20	130	
160	175	212	-	140.3	135.4	129.4	121.5	-	45	28	4	20	130	
180	1) 188	212	-	157.8	152.3	144.9	136.7	30	50	30	4	20	130	
200	232	268	-	175.3	169.2	160.9	151.7	32	52	30	4	20	150	
225	235	268	-	197.2	189.6	181.1	170.7	32	52	30	4	20	150	
250	285	320	-	219.3	210.8	201.3	189.9	-	35	65	30	4	20	150
280	291	320	-	244.8	236.0	225.5	212.5	-	40	40	4	20	150	
315	335	370	291.9	275.4	265.5	253.6	239.1	40	65	40	4	20	150	
355	373	430	328.8	310.2	299.2	258.8	269.3	46	65	45	6	20	170	
400	427	482	370.6	349.7	337.2	322.0	303.5	60	70	60	6	20	170	
450	1) 482	1) 545	416.3	393.4	379.3	362.2	341.5	-	50	50	6	20	170	
500	530	585	462.5	437.0	421.4	402.5	379.6	60	70	60	6	20	170	
560	615	1) 656	517.9	489.5	471.9	450.8	-	-	40	40	6	20	170	
630	642	685	582.8	550.7	531.3	507.1	-	50	70	50	6	20	170	
710	737	800	656.7	620.6	598.4	-	-	55	-	50	8	20	170	
800	840	905	739.9	699.4	674.3	-	-	60	-	70	8	20	190	
900	944	1005	832.4	786.9	-	-	-	60	-	70	8	20	190	
1000	1047	1110	924.9	874.1	-	-	-	60	-	70	8	20	190	
1200	1245	1330	1109.6	-	-	-	-	60	-	70	8	20	190	

1) DIN 16963 norm part 4.

3) The H1 values correspond to those of higher PN.

2) D5 consider average values. ISO 11922-1 norm.

4) Z1 corresponds to Z1 min. Plus 50mm.

Office Address:

No.8 (Suit 6), Nour Alley, Africa St., Tehran/IRAN.....

Tel.: (+98 21) 88 67 79 65 , 88 67 79 66, 88 67 39 19 , 88 67 39 18 - Fax: (+98 21) 88 87 85 81